

# Harnais Principal

## ELECT-EP0543-A

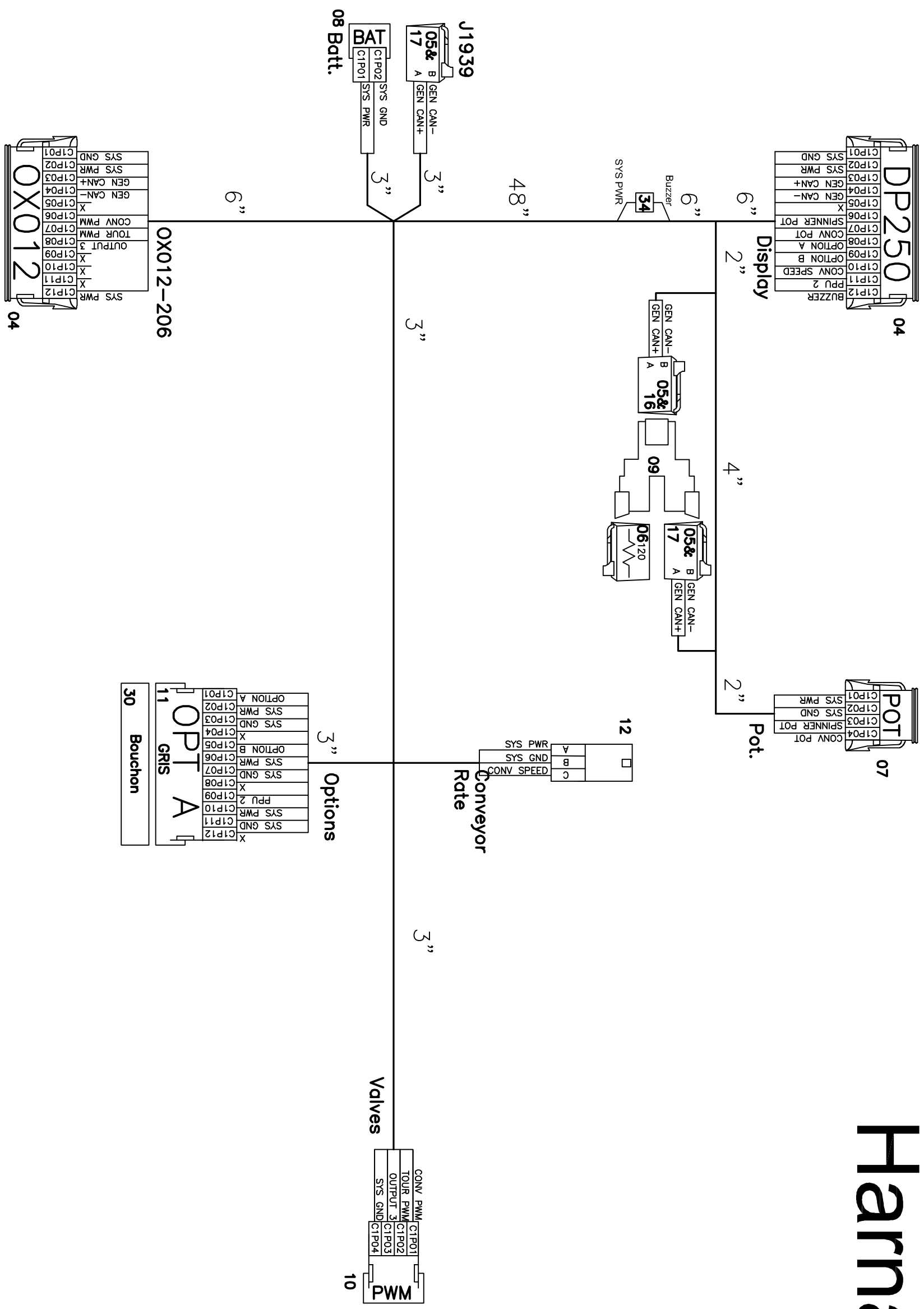

# Boîtier à Potentiomètre

ELECT-EP0543-B

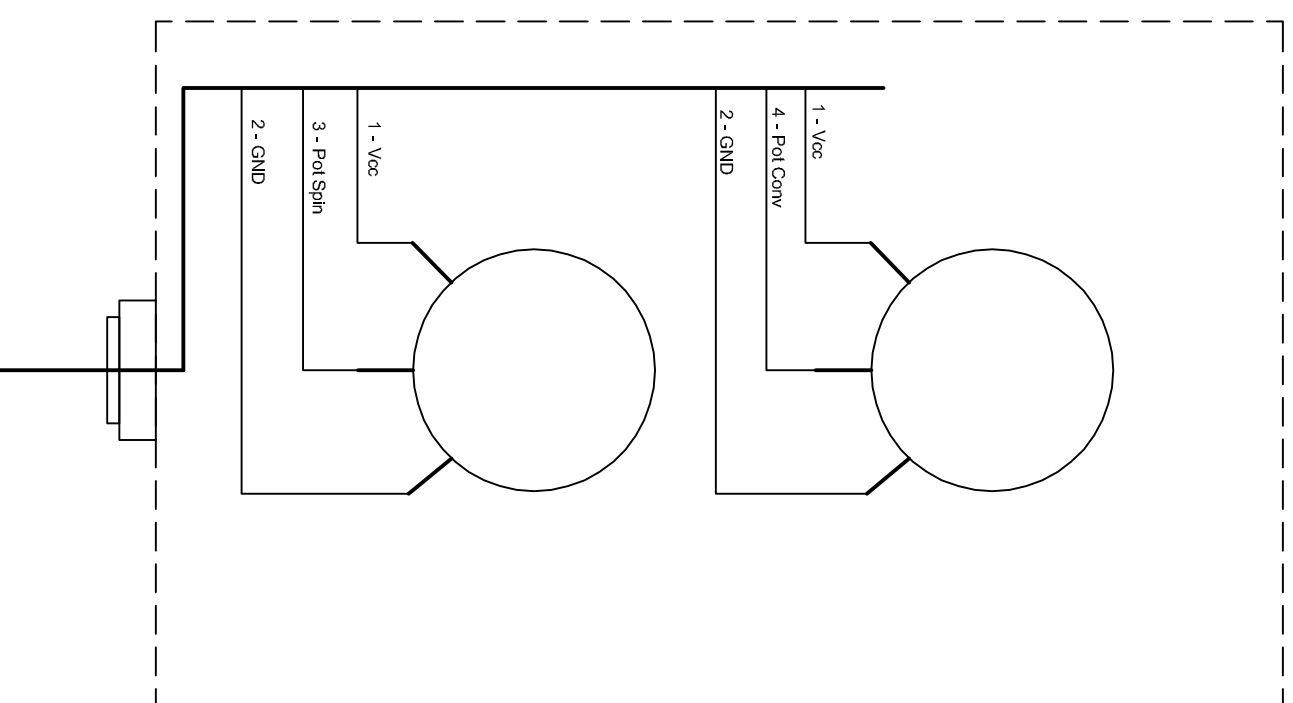
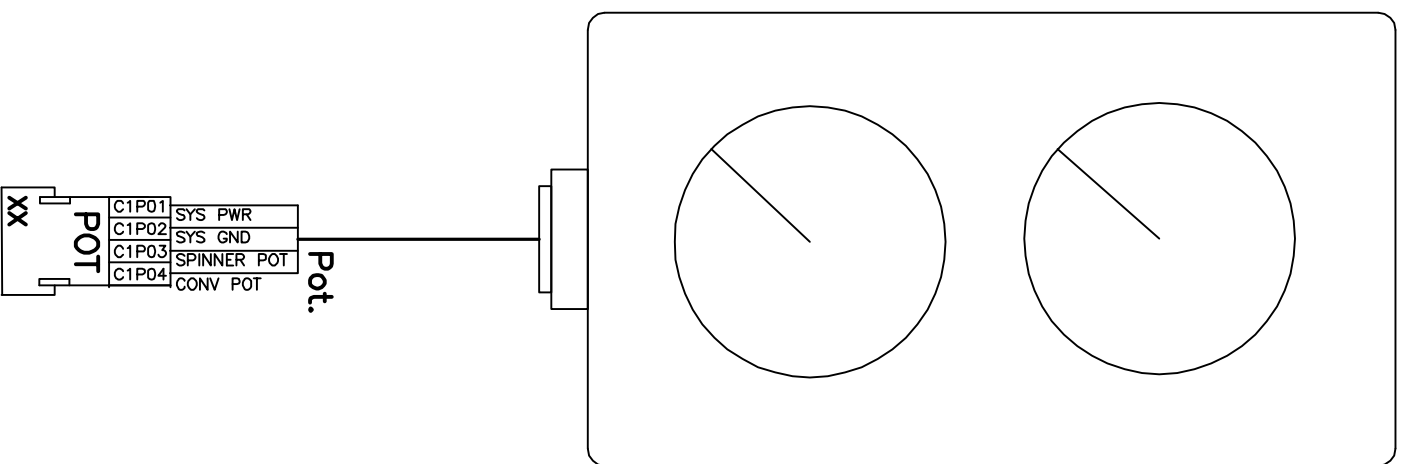

# Cable alimentation

ELECT-EP0543-C

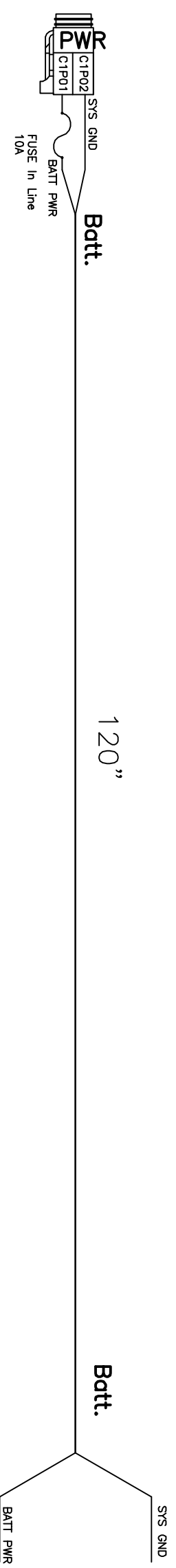

# Cable Engine CAN

ELECT-EP0543-D

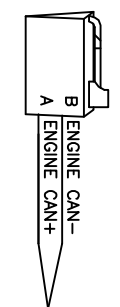

J1939

120"

J1939

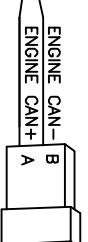

# Câble PWM

ELECT-EP0543-E

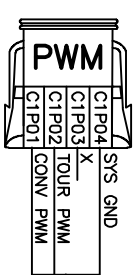
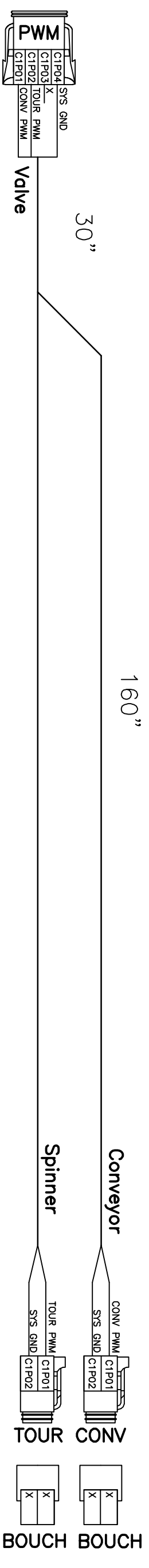

# Câble PWM 2

ELECT-EP0543-E2

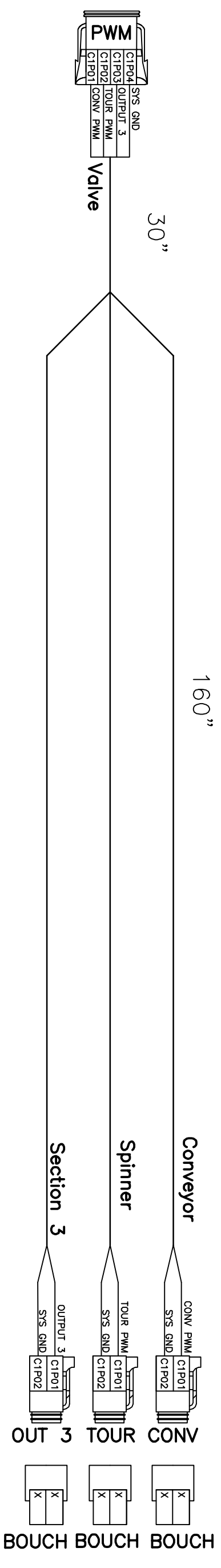

# Cable capteur convoyeur

ELECT-EP0543-F

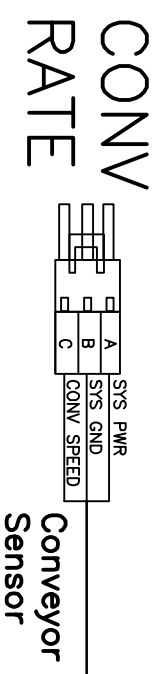

200'

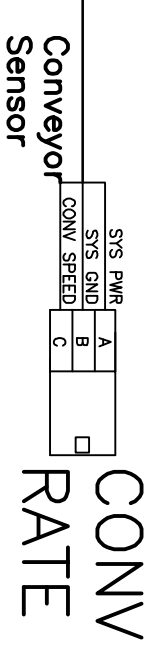

# Cable Option A

ELECT-EP0543-G

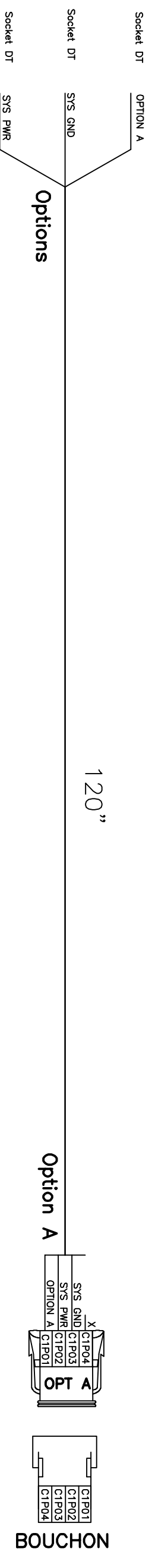



# Cable Option B

ELECT-EP0543-H

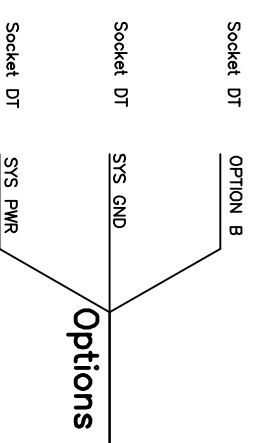

120"

Option B

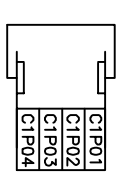
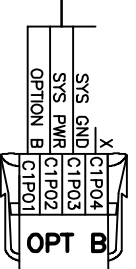

BOUCHON

# Cable Option PPU2

ELECT-EP0543-1

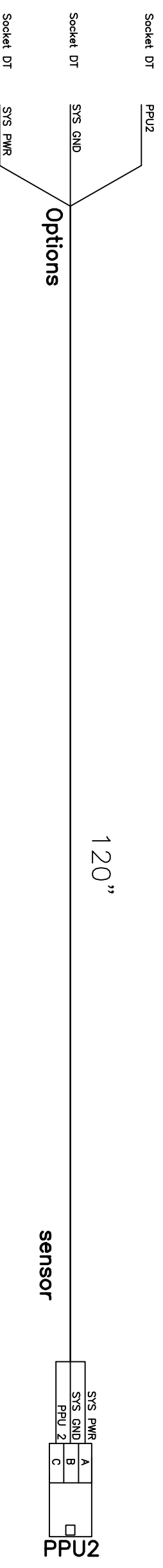

# Cable Power Switch

ELECT-EP0543-K

